

THIS DRAWING AND DESIGN IS A PROPERTY OF 'FIRETECH' AND MUST NOT BE COPIED OR LEND WITHOUT THEIR PERMISSION IN WRITING.

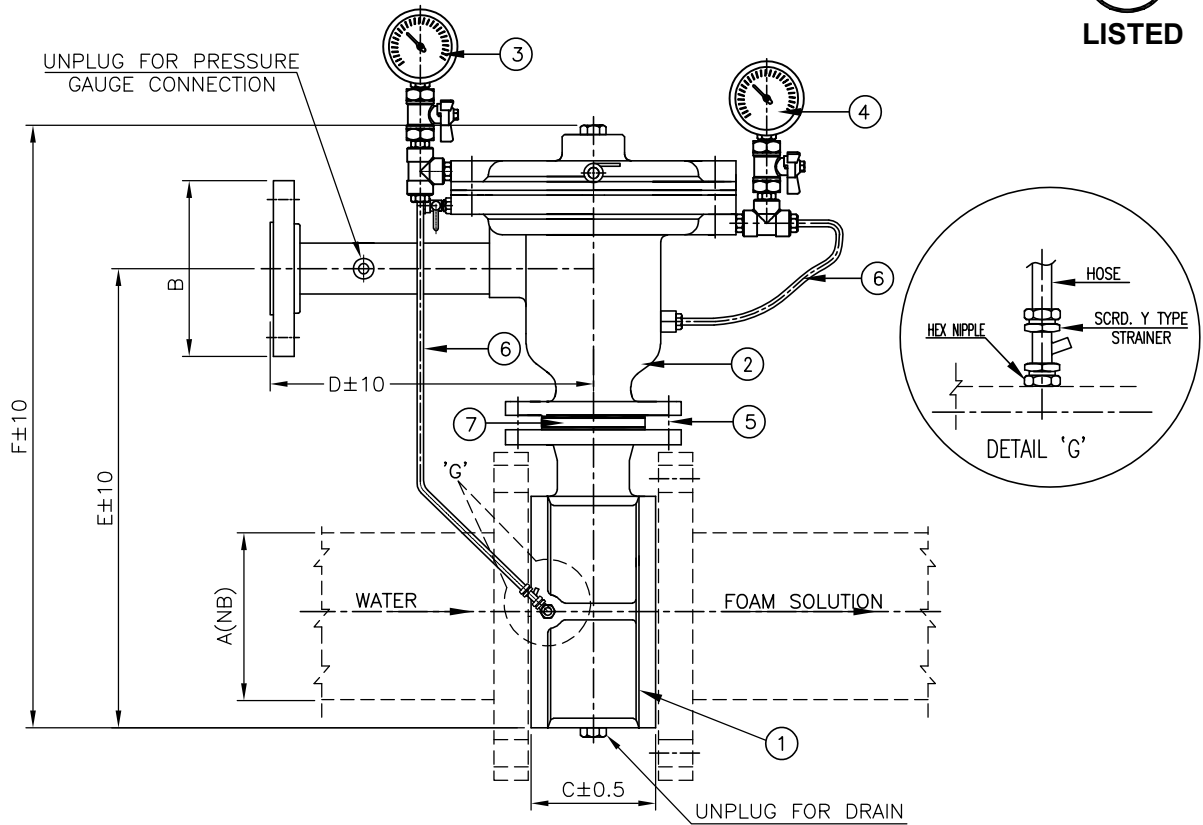

MATERIAL OF CONSTRUCTION

SR.NO.	DESCRIPTION	MATERIAL
1	FOAM PROPORTIONER	STAINLESS STEEL (SS:304)
2	PRESSURE BALANCING VALVE	STAINLESS STEEL (SS:304)
3	PRESSURE GAUGE-WATER	63MM DIAL,0-21KG/SQ.CM,SS:316 INTERNAL
4	PRESSURE GAUGE-FOAM	63MM DIAL,0-21KG/SQ.CM,SS:316 INTERNAL
5	NUT,BOLT	STAINLESS STEEL (SS:304)
6	PRESSURE TRIM HOSE	STAINLESS STEEL (SS:304)
7	FOAM ORIFICE	STAINLESS STEEL (SS:304)

TECHNICAL DETAILS

1.MIN. WORKING PRESSURE : 3 BAR
2.MAX.WORKING PRESSURE : 12 BAR
3.HYDRO STATIC TEST : 18 BAR FOR 5 MINUTES.
4.FINISH:-PAINTED FIRE-RED TO SHADE RAL 3000
5. ΔP-DIFFERENTIAL PRESSURE BETWEEN WATER & FOAM SHOULD BE IN BETWEEN 1 BAR TO 2.75 BAR

DIMENSIONAL & FLOW RANGE DETAILS

MODEL	A(NB)	B(NB)	C	D	E	F	FLOW RANGE(LPM)	PROP.RATIO
ILBP-65-S4	65	40	100	250	305	400	300-2100	3%
ILBP-80-S4	80	40	110	250	325	420	500-3300	3%
ILBP-100-S4	100	40	110	250	365	460	1500-8000	3%
ILBP-150-S4	150	50	130	260	430	550	2000-11000	3%

NOTE:-1. ALL DIMENSIONS ARE IN mm,UNLESS OTHERWISE STATED.



INLINE BALANCED PRESSURE FOAM PROPORTIONER
STAINLESS STEEL (SS:304)

DRG.NO.

666-MKT-A1-S4

R

1